

# Bridgelux LS Array Series

## Data Sheet DS 20

### BXRB – XXX0360-X, -56C0470-X

#### Introduction

The Bridgelux family of LED Array products delivers high performance, compact and cost-effective solid-state lighting solutions to serve the general lighting market. These products combine the higher efficacy, lifetime, and reliability benefits of LEDs with the light output levels of many conventional lighting sources. The Bridgelux LS Array Series has been specified to enable lamp and luminaire designs which are thermally limited to a maximum of 4-5 Watts, including replacement lamps, decorative lighting and white goods applications.

The Bridgelux LS Array Series provides a high performance alternative to conventional solid state solutions, delivering between 300 and 470 lumens under application conditions in warm and cool white color temperatures. These compact high flux density light sources deliver uniform high quality illumination without pixilation or the multiple shadow effect caused by LED component based solutions, enabling both diffuse and directional lamp replacements for a wide range of applications. To simplify system design for appropriate light output, Bridgelux LED Arrays are specified to deliver performance under typical use conditions.

These integrated plug and play solutions reduce system complexity and enable miniaturized cost-effective lamp and luminaire designs. Lighting system designs incorporating these LED Arrays deliver performance comparable to that of a 20-40 Watt incandescent, 20-35 Watt halogen and low wattage compact fluorescent lamps and luminaires and feature increased system level efficacy and service life. Typical applications include replacement lamps, task lighting, under cabinet, accent, pendant, sconces, porch, pathway, landscape, portable, and consumer luminaires and white goods.

#### Features

- Compact high flux density light source
- Uniform high quality illumination
- Streamlined thermal path
- Energy Star / ANSI compliant binning structure
- More energy efficient than incandescent, halogen and fluorescent lamps
- Low voltage DC operation
- Instant light with unlimited dimming
- 5-year warranty
- RoHS compliant and Pb free

#### Benefits

- Enhanced optical control
- Clean white light without pixilation
- Significantly reduced thermal resistance and increased operating temperatures
- Uniform consistent white light
- Lower operating costs
- Increased safety
- Easy to use with daylight and motion detectors to enable increased energy savings
- Reduced maintenance costs
- Environmentally friendly, no disposal issue

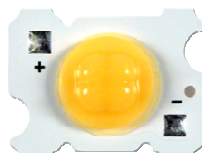

---

Table of Contents	Page
Product Nomenclature	3
Average Lumen Maintenance Characteristics	3
Environmental Compliance	3
UL Recognition	4
Minor Product Change Policy	4
Cautionary Statements	4
Case Temperature Measurement Point	5
Quick Selection Guide	6
Flux Characteristics	7
Optical Characteristics	8
Electrical Characteristics	9
Absolute Minimum and Maximum Ratings	10
Typical Performance at Alternative Drive Currents	11
Mechanical Dimensions	13
Typical Radiation Pattern	14
Wavelength Characteristics at Rated Test Current, $T_j=25^\circ\text{C}$	15
Typical Relative Luminous Flux vs. Current, $T_j=25^\circ\text{C}$	16
Typical Light Output Characteristics vs. Temperature	17
Typical Chromaticity Characteristics vs. Temperature	18
Typical Forward Current Characteristics at $T_j = 25^\circ\text{C}$	19
Product Binning	20
Color Binning Information	21
Design Resources	23

---

## Product Nomenclature

The part number designation for BXR B product families of Bridgelux LED Arrays is explained as follows:

B X R B – A A B C C C C – D – E E – F F F

Where:

B X R B: Designates product family

A A: Designates color  
27 for 2700K ANSI Bin  
30 for 3000K ANSI Bin  
56 for 5600K ANSI Bin

B: Designates minimum CRI  
C = 70, E = 80, G = 90

C C C C: Designates nominal flux  
0360 = 360 lm            0470 = 470 lm

D: Designates configuration options, specific to each array family

E E: Designates color binning  
00 = Full ANSI bin, 7 SDCM  
03 = 3 SDCM binning option

F F F: Designates wiring options, not applicable for LS Arrays

## Average Lumen Maintenance Characteristics

Bridgelux projects that its family of LED Array products will deliver, on average, greater than 70% lumen maintenance after 50,000 hours of operation at the rated forward test current. This performance assumes constant current operation with case temperature maintained at or below 70°C. For use beyond these typical operating conditions please consult your Bridgelux sales representative for further assistance.

These projections are based on a combination of package test data, semiconductor chip reliability data, a fundamental understanding of package related degradation mechanisms, and performance observed from products installed in the field using Bridgelux die technology. Bridgelux conducts lumen maintenance tests per LM80. Observation of design limits is required in order to achieve this projected lumen maintenance.

## Environmental Compliance

Bridgelux is committed to providing environmentally friendly products to the solid-state lighting market. Bridgelux LED Arrays are compliant to the European Union directives on the restriction of hazardous substances in electronic equipment, namely the RoHS directive. Bridgelux will not intentionally add the following restricted materials to LED Array products: lead, mercury, cadmium, hexavalent chromium, polybrominated biphenyls (PBB) or polybrominated diphenyl ethers (PBDE).

---

## UL Recognition

Bridgelux secures UL Recognition for all the LED Array products. We continue to add arrays as they are recognized by UL. Please refer to the UL file E333389 for the latest list of UL Recognized Arrays. Bridgelux uses UL Recognized materials with suitable flammability ratings in the LED Array to streamline the process for customers to secure UL listing of the final luminaire product. Bridgelux recommends that luminaires are designed with a Class 2 Driver to facilitate the UL listing process.

## Minor Product Change Policy

The rigorous qualification testing on products offered by Bridgelux provides performance assurance. Slight cosmetic changes that do not affect form, fit, or function may occur as Bridgelux continues product optimization.

## Cautionary Statements

### CAUTION: CONTACT WITH OPTICAL AREA

Contact with the resin area should be avoided. Applying stress to the resin area can result in damage to the product.

### CAUTION: EYE SAFETY

Eye safety classification for the use of Bridgelux LED Arrays is in accordance with IEC – EN62471 Photobiological Safety of Lamps and Lamp Systems specification. Bridgelux LED Arrays are classified as Risk Group 1 (Low Risk) when operated at or below the rated test current. Please use appropriate precautions. It is important that employees working with LEDs are trained to use them safely.

### CAUTION: RISK OF BURN

Do not touch the LED Array or resin area during operation. Allow the LED Array to cool for a sufficient period of time before handling. The LED Array may reach elevated temperatures such that it can burn skin when touched.

### CAUTION: CHEMICAL EXPOSURE HAZARD

Exposure to some chemicals commonly used in luminaire manufacturing and assembly can cause damage to the LED Array. Please consult Application Note AN11 for additional information.

---

## Case Temperature Measurement Point

A case temperature measurement point location is included on the top surface of the Bridgelux LED Arrays. The location of this measurement point is indicated in the mechanical dimensions section of this data sheet.

The purpose of this measurement point is to allow the user access to a measurement point closely linked to the true case temperature on the back surface of the LED Array. Once the LED Array is installed, it is challenging to measure the back surface of the array, or true case temperature. Measuring the top surface of the product can lead to inaccurate results due to the poor thermal conductivity of the top layers of the array such as the solder mask and other materials.

Bridgelux has provided the case temperature measurement location in a manner which closely ties it to the true case temperature of the LED Array under steady state operation. Deviations between thermal measurements taken at the point indicated and the back of the LED Array differ by less than 1 °C, providing a robust method to testing thermal operation once the product is installed.

## Quick Selection Guide

Table 1: Quick Selection Guide for LS Arrays

<b>Base Part Number</b>	<b>CCT</b> (Nominal)	<b>CRI</b> (min)	<b>Typ Flux</b> <b>25°C</b> (lm)	<b>Min Flux</b> <b>25°C</b> (lm)	<b>Typ Flux</b> <b>70°C</b> (lm)	<b>Current</b> (mA)	<b>Vf</b> (Typ) (V)	<b>Power</b> (Typ) (W)	<b>Efficacy</b> (Typ at Tc 25°C) (lm/W)
BXRB-27E0360-B-00	2700	80	370	330	330	730	6.2	4.5	82
BXRB-30E0360-B-00	3000	80	400	360	360	730	6.2	4.5	88
BXRB-27G0360-B-00	2700	90	330	300	300	730	6.2	4.5	73
BXRB-30G0360-B-00	3000	90	360	320	320	730	6.2	4.5	80
BXRB-27E0360-A-00	2700	80	370	330	330	365	12.4	4.5	82
BXRB-30E0360-A-00	3000	80	400	360	360	365	12.4	4.5	88
BXRB-27G0360-A-00	2700	90	330	300	300	365	12.4	4.5	73
BXRB-30G0360-A-00	3000	90	360	320	320	365	12.4	4.5	80
BXRB-56C0470-B-00	5600	70	520	470	470	730	6.2	4.5	115
BXRB-56C0470-A-00	5600	70	520	470	470	365	12.4	4.5	115

## Flux Characteristics

Table 2: Flux Characteristics

Color	Part Number	CRI (min)	Typ Luminous Flux (lm) T <sub>c</sub> =70 °C <sup>[3]</sup>	Min Luminous Flux (lm) T <sub>j</sub> =25 °C <sup>[1]</sup>	Typ Luminous Flux (lm), T <sub>j</sub> =25 °C	Max Luminous Flux (lm), T <sub>j</sub> =25 °C	Test Current (mA) <sup>[2,4]</sup>
Warm White	BXRB-27E0360-B-00	80	330	330	370	410	730
	BXRB-30E0360-B-00	80	360	360	400	440	730
	BXRB-27G0360-B-00	90	300	300	330	360	730
	BXRB-30G0360-B-00	90	320	320	360	400	730
	BXRB-27E0360-A-00	80	330	330	370	410	365
	BXRB-30E0360-A-00	80	360	360	400	440	365
	BXRB-27G0360-A-00	90	300	300	330	360	365
	BXRB-30G0360-A-00	90	320	320	360	400	365
Cool White	BXRB-56C0470-B-00	70	470	470	520	580	730
	BXRB-56C0470-A-00	70	470	470	520	580	365

Notes for Table 2:

1. Bridgelux maintains a  $\pm 7\%$  tolerance of flux measurements.
2. Parts are tested in pulsed conditions, T<sub>j</sub> = 25°C. Pulse width is 10 ms at rated test current.
3. Typical performance when driven with direct current using Bridgelux test set-up. Please contact a Bridgelux sales representative for additional details.
4. Reference Table 7 and 8 for typical performance at other driver currents (including those commonly available in the market)

## Optical Characteristics

Table 3: Optical Characteristics

Color	Part Number	Color Temperature (CCT) <sup>[1],[2],[3]</sup>			Minimum Color Rendering Index <sup>[4]</sup>	Typical Viewing Angle (Degrees) $2\theta_{1/2}$ <sup>[5]</sup>	Typical Center Beam Candle Power (cd) <sup>[6]</sup>
		Min	Typ	Max			
Warm White	BXRB-27E0360-B-00	2580 K	2725 K	2870 K	80	140	120
	BXRB-30E0360-B-00	2870 K	3045 K	3220 K	80	140	130
	BXRB-27G0360-B-00	2580 K	2725 K	2870 K	90	140	105
	BXRB-30G0360-B-00	2870 K	3045 K	3220 K	90	140	115
	BXRB-27E0360-A-00	2580 K	2725 K	2870 K	80	140	120
	BXRB-30E0360-A-00	2870 K	3045 K	3220 K	80	140	130
	BXRB-27G0360-A-00	2580 K	2725 K	2870 K	90	140	105
	BXRB-30G0360-A-00	2870 K	3045 K	3220 K	90	140	115
Cool White	BXRB-56C0470-B-00	5310 K	5665 K	6020 K	70	140	165
	BXRB-56C0470-A-00	5310 K	5665 K	6020 K	70	140	165

Notes for Table 3:

1. Parts are tested in pulsed conditions,  $T_j = 25^\circ\text{C}$ . Pulse width is 10 ms at rated test current.
2. Refer to Flux Characteristic Table for test current data.
3. Product is binned for color in x y coordinates.
4. Higher CRI options available upon request.
5. Viewing angle is the off axis angle from the centerline where  $I_v$  is  $\frac{1}{2}$  of the peak value.
6. Center beam candle power is a calculated value based on lambertian radiation pattern at nominal test current (365mA or 730mA).

## Electrical Characteristics

Table 4: Electrical Characteristics

Color	Base Part Number	Forward Voltage Vf (V) <sup>[1],[2]</sup>			Test Current (mA)	Typical Temperature Coefficient of Forward Voltage (mV/°C) $\Delta V_f/\Delta T_j$	Typical Thermal Resistance Junction to Case (°C/W) $R_{\theta_{j-c}}$
		Min	Typ	Max			
Warm White	BXRB-27E0360-B-00	5.6	6.2	6.8	730	-2 to -6	3.5
	BXRB-30E0360-B-00	5.6	6.2	6.8	730	-2 to -6	3.5
	BXRB-27G0360-B-00	5.6	6.2	6.8	730	-2 to -6	3.5
	BXRB-30G0360-B-00	5.6	6.2	6.8	730	-2 to -6	3.5
	BXRB-27E0360-A-00	11.2	12.4	13.6	365	-4 to -12	3.5
	BXRB-30E0360-A-00	11.2	12.4	13.6	365	-4 to -12	3.5
	BXRB-27G0360-A-00	11.2	12.4	13.6	365	-4 to -12	3.5
	BXRB-30G0360-A-00	11.2	12.4	13.6	365	-4 to -12	3.5
Cool White	BXRB-56C0470-B-00	5.6	6.2	6.8	730	-2 to -6	3.5
	BXRB-56C0470-A-00	11.2	12.4	13.6	365	-4 to -12	3.5

Notes for Table 4:

1. Parts are tested in pulsed conditions,  $T_j = 25^\circ\text{C}$ . Pulse width is 10 ms at rated test current.
2. Bridgelux maintains a tester tolerance of  $\pm 0.10$  V on forward voltage measurements.

## Absolute Minimum and Maximum Ratings

Table 5: Minimum and Maximum Current and Reverse Voltage Ratings

Part Number	Maximum DC Forward Current (mA)	Maximum Peak Pulsed Current (mA) <sup>[1]</sup>	Maximum Reverse Voltage (Vr) <sup>[2]</sup>
BXRB-27E0360-B-00	1000	1400	-10 Volts
BXRB-30E0360-B-00	1000	1400	-10 Volts
BXRB-27G0360-B-00	1000	1400	-10 Volts
BXRB-30G0360-B-00	1000	1400	-10 Volts
BXRB-27E0360-A-00	500	700	-20 Volts
BXRB-30E0360-A-00	500	700	-20 Volts
BXRB-27G0360-A-00	500	700	-20 Volts
BXRB-30G0360-A-00	500	700	-20 Volts
BXRB-56C0470-B-00	1000	1400	-10 Volts
BXRB-56C0470-A-00	500	700	-20 Volts

Notes for Table 5:

1. Bridgelux recommends a maximum duty cycle of 10% when operating LED Arrays at the maximum peak pulsed current specified.
2. Light emitting diodes are not designed to be driven in reverse voltage.

Table 6: Maximum Ratings

Parameter	Maximum Rating
LED Junction Temperature	150°C
Storage Temperature	-40°C to +105°C
Operating Case Temperature	105°C at rated test current (see Table 4) 85°C at maximum DC Forward current (see Table 5)
Soldering Temperature	350°C or lower for a maximum of 3.5 seconds

## Typical Performance at Alternative Drive Currents

The Bridgelux LED Arrays are tested and binned against the specifications shown in Tables 2, 3 and 4. Customers also have options to drive the LED Arrays at alternative drive currents dependent on the specific application. The typical performance at any drive current can be derived from the flux vs. current characteristics shown in Figure 5 and 6 and from the current vs. voltage characteristics shown in Figures 10 and 11. The typical performance at common drive currents is also summarized in Table 7.

Table 7: Typical Product Performance at Alternative Drive Currents

Color	Part Number	Typical Luminous Flux $\phi_v$ (lm), $T_{case}=70^{\circ}C$	Typical Luminous Flux $\phi_v$ (lm), $T_j=25^{\circ}C$	Typical Forward Voltage $V_f$ (V)	Forward Current (mA) <sup>[2]</sup>
Warm White	BXR-27E0360-B-00	240	270	5.9	500
		315	350	6.2	700
		<b>330</b>	<b>370</b>	<b>6.2</b>	<b>730</b> <sup>[1]</sup>
		430	475	6.5	1000
	BXR-30E0360-B-00	260	290	5.9	500
		350	385	6.2	700
		<b>360</b>	<b>400</b>	<b>6.2</b>	<b>730</b> <sup>[1]</sup>
		465	515	6.5	1000
	BXR-27G0360-B-00	215	240	5.9	500
		290	320	6.2	700
		<b>300</b>	<b>330</b>	<b>6.2</b>	<b>730</b> <sup>[1]</sup>
		380	425	6.5	1000
	BXR-30G0360-B-00	235	260	5.9	500
		315	350	6.2	700
		<b>325</b>	<b>360</b>	<b>6.2</b>	<b>730</b> <sup>[1]</sup>
		420	465	6.5	1000
	BXR-27E0360-A-00	240	270	11.8	250
		315	350	12.4	350
		<b>330</b>	<b>370</b>	<b>12.4</b>	<b>365</b> <sup>[1]</sup>
		430	475	13	500
	BXR-30E0360-A-00	260	290	11.8	250
		350	385	12.4	350
		<b>360</b>	<b>400</b>	<b>12.4</b>	<b>365</b> <sup>[1]</sup>
		465	515	13	500
	BXR-27G0360-A-00	215	240	11.8	250
		290	320	12.4	350
		<b>300</b>	<b>330</b>	<b>12.4</b>	<b>365</b> <sup>[1]</sup>
		380	425	13	500
	BXR-30G0360-A-00	235	260	11.8	250
		315	350	12.4	350
		<b>325</b>	<b>360</b>	<b>12.4</b>	<b>365</b> <sup>[1]</sup>
		420	465	13	500

Table 8: Typical Product Performance at Alternative Drive Currents

Color	Part Number	Typical Luminous Flux $\phi_v$ (lm), $T_{case}=70^\circ\text{C}$	Typical Luminous Flux $\phi_v$ (lm), $T_j=25^\circ\text{C}$	Typical Forward Voltage $V_f$ (V)	Forward Current (mA) <sup>[2]</sup>
Cool White	BXR-56C0470-B-00	340	375	5.9	500
		450	500	6.2	700
		<b>470</b>	<b>520</b>	<b>6.2</b>	<b>730</b> <sup>[1]</sup>
		600	670	6.5	1000
	BXR-56C0470-A-00	340	375	11.8	250
		450	500	12.4	350
		<b>470</b>	<b>520</b>	<b>12.4</b>	<b>365</b> <sup>[1]</sup>
		600	670	13	500

Notes for Table 7 and 8:

1. Product is tested and binned at the specified drive current.
2. Operating these LED Arrays at or below the drive currents listed in Table 7 and 8, with a case temperature maintained at or below 70°C, will enable the average lumen maintenance projection outlined earlier in this Product Data Sheet.

## Mechanical Dimensions

Figure 1: Drawing for all BXRB LS Array parts.

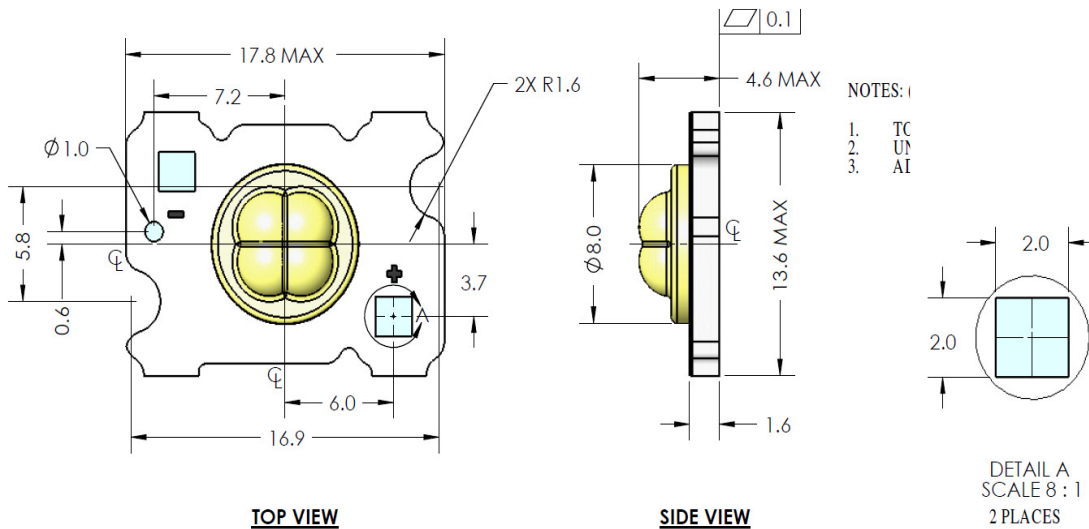

### Notes for Figure 1:

1. Slots are for M2.5 or #4 screws.
2. Solder pads are labeled "+" and "-" to denote positive and negative, respectively.
3. Drawings are not to scale.
4. Drawing dimensions are in millimeters.
5. Unless otherwise specified, tolerances are  $\pm 0.20\text{mm}$ .
6. Refer to product Application Notes AN10 and AN11 for product handling, mounting and heat sink recommendations.
7. The optical center of the LED Array is defined by the mechanical center of the array.

## Typical Radiation Pattern

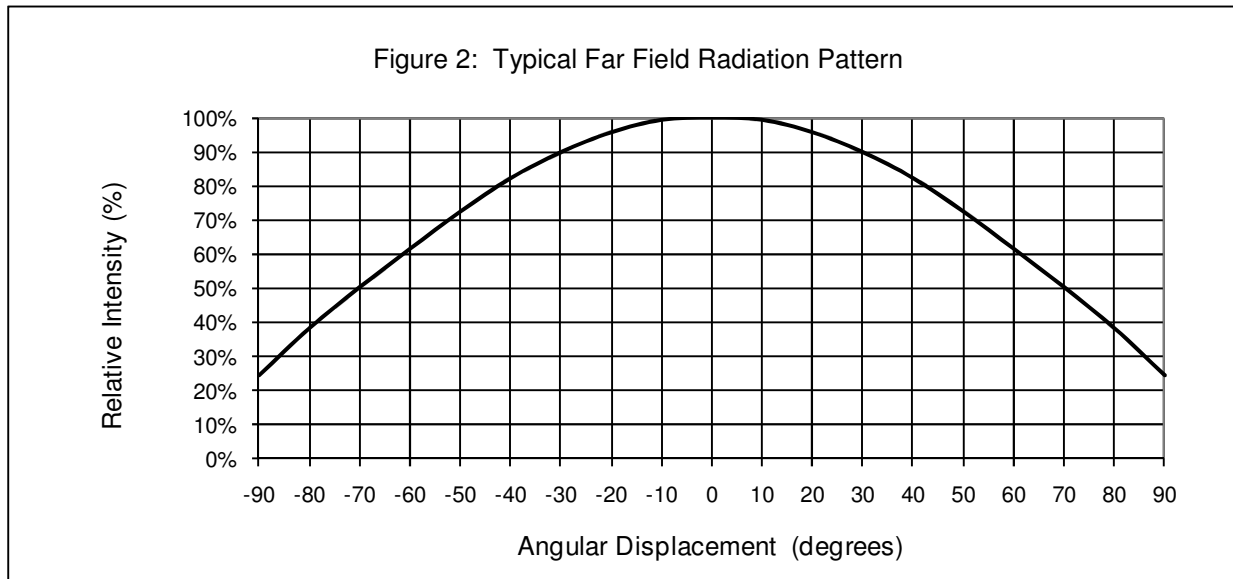
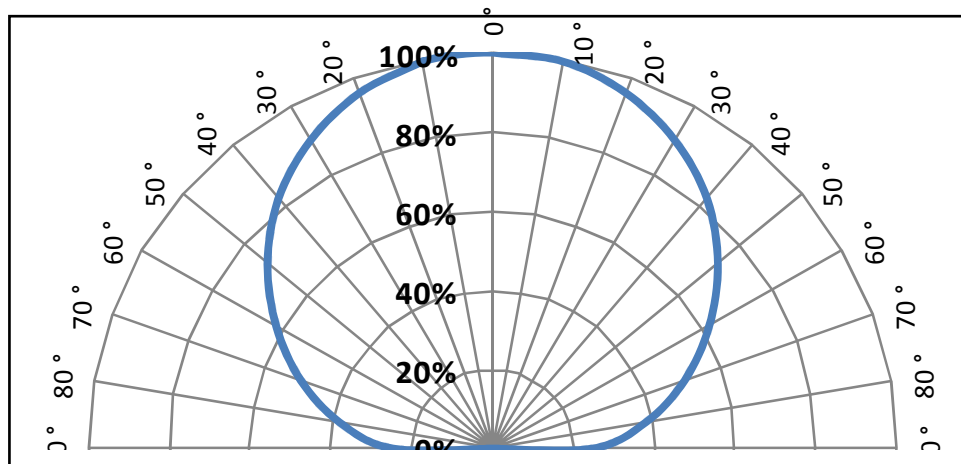
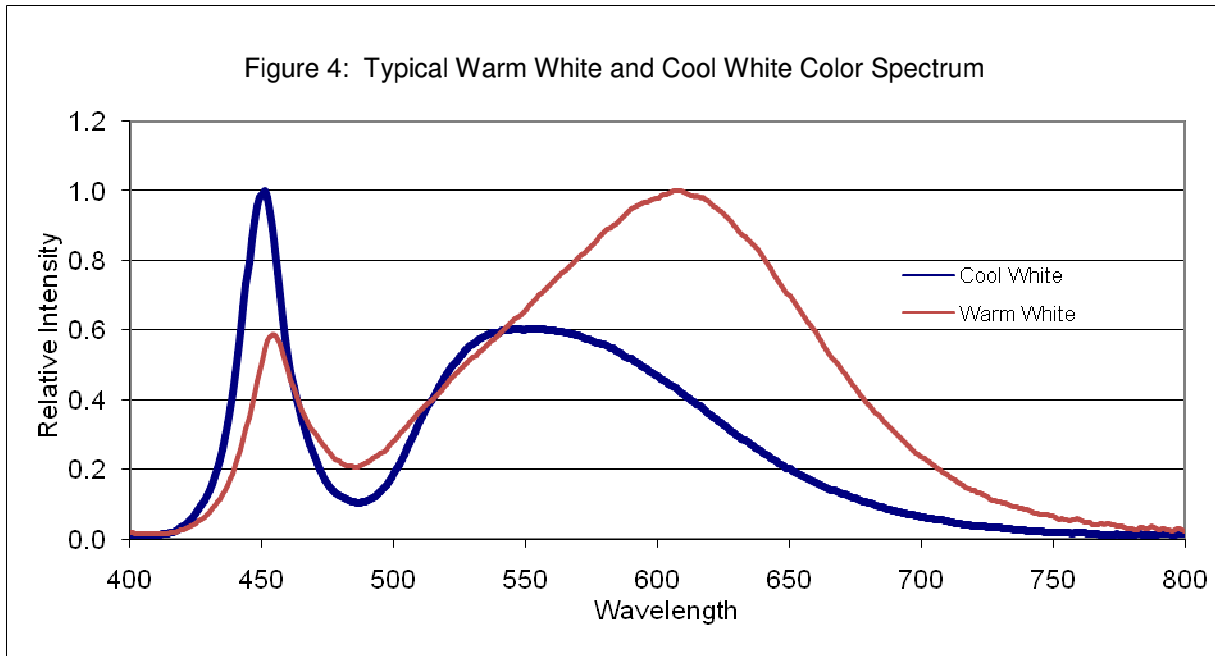

Figure 3: Typical Far Field Polar Radiation Pattern



Wavelength Characteristics at Rated Test Current,  $T_j=25^\circ\text{C}$



Typical Relative Luminous Flux vs. Current,  $T_j=25^\circ\text{C}$

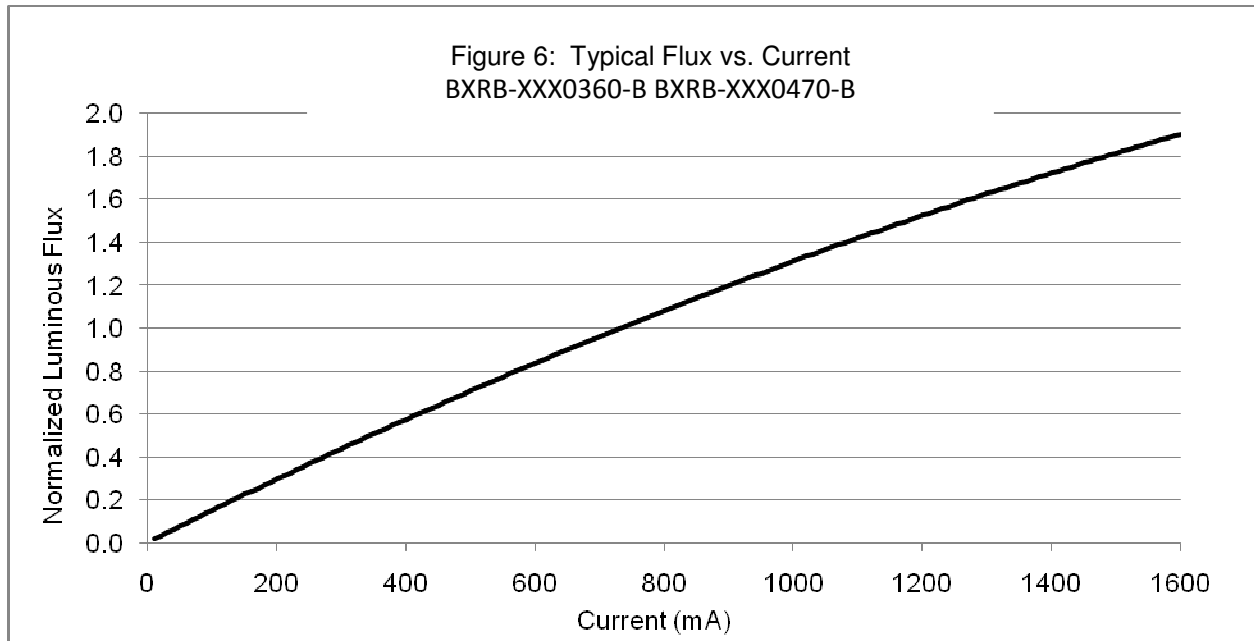
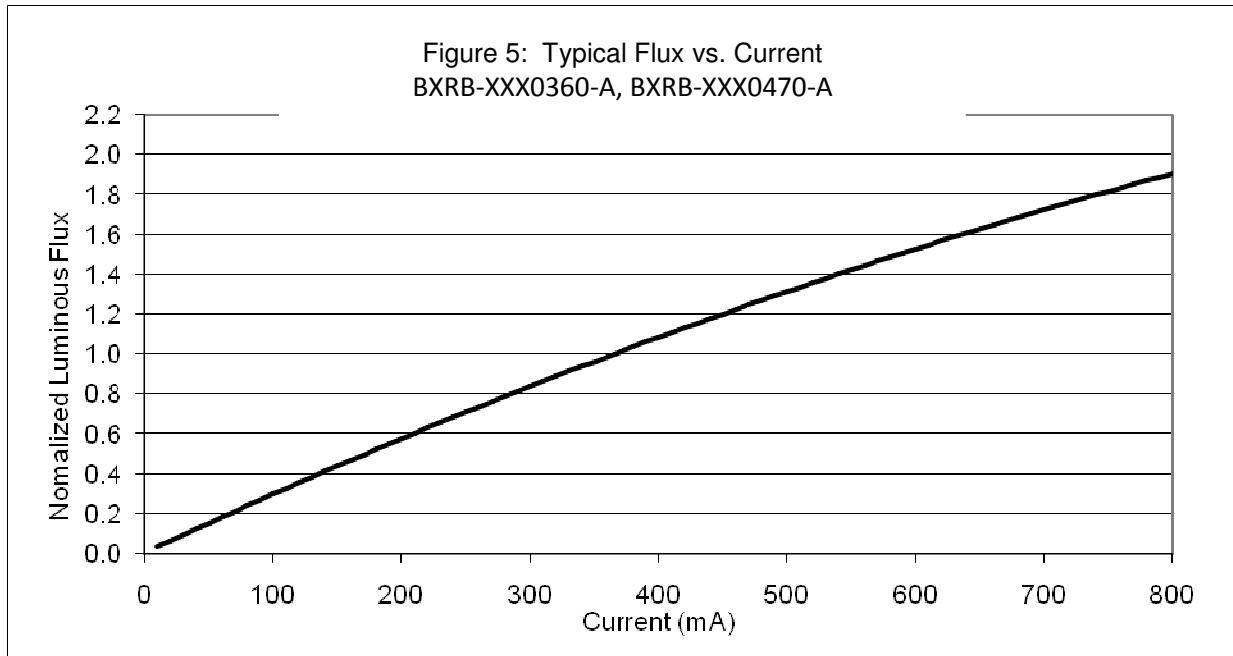

## Typical Light Output Characteristics vs. Temperature

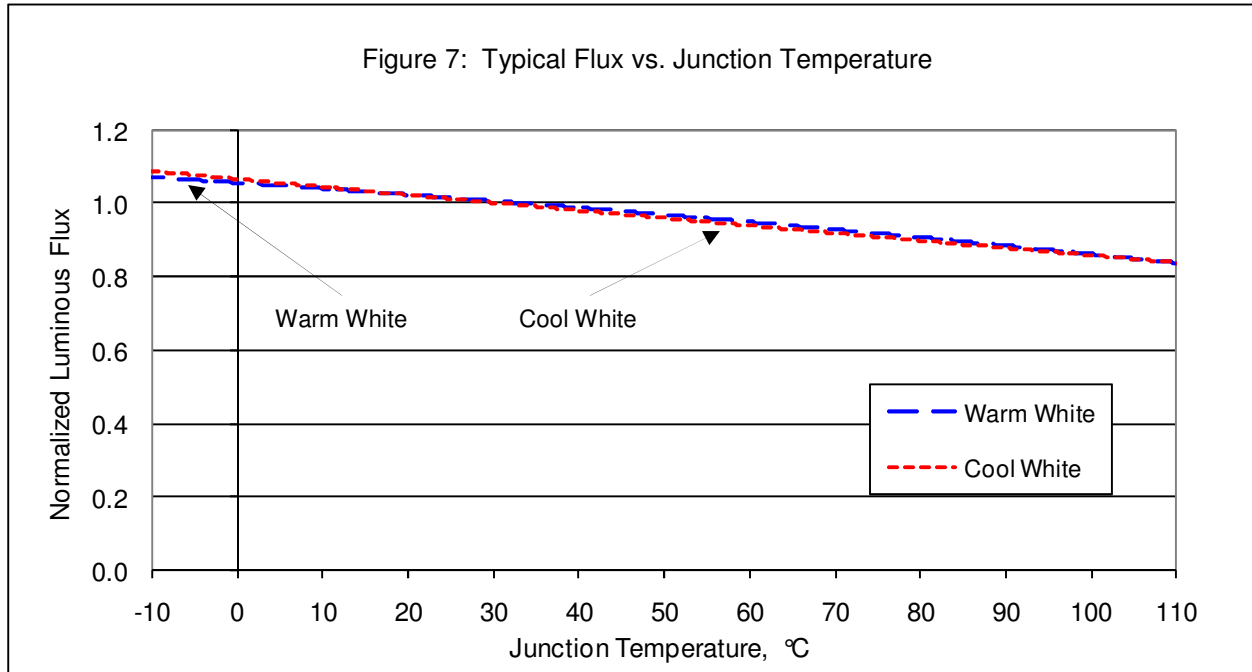

## Typical Chromaticity Characteristics vs. Temperature

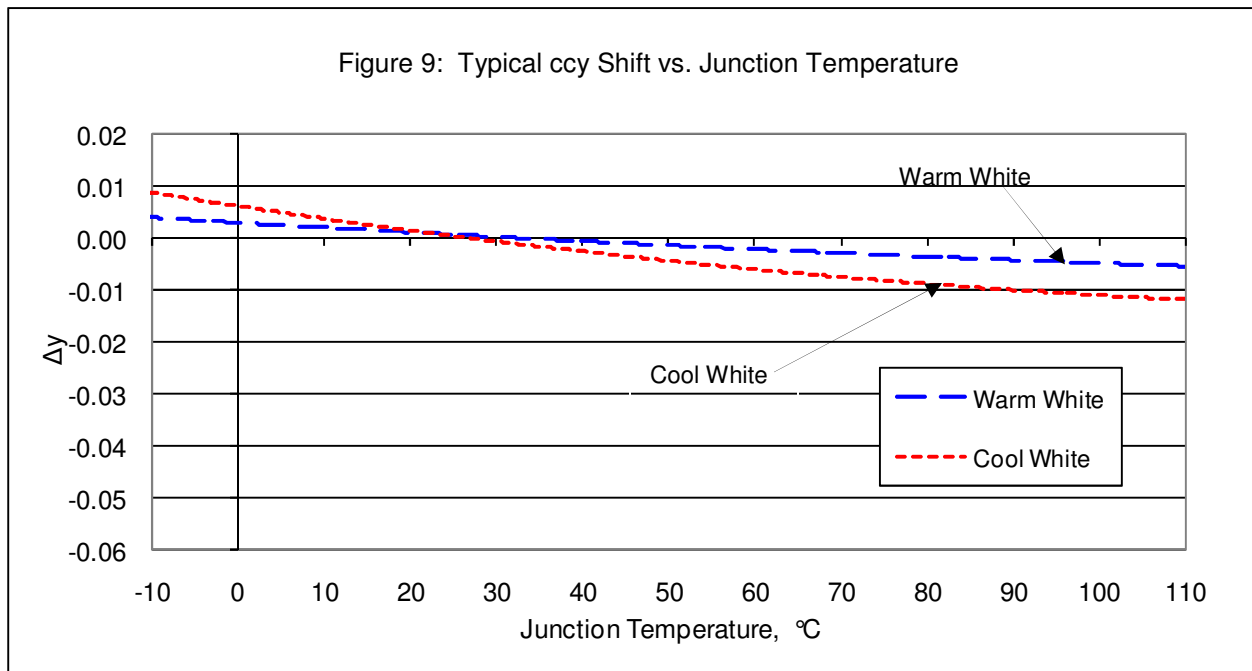
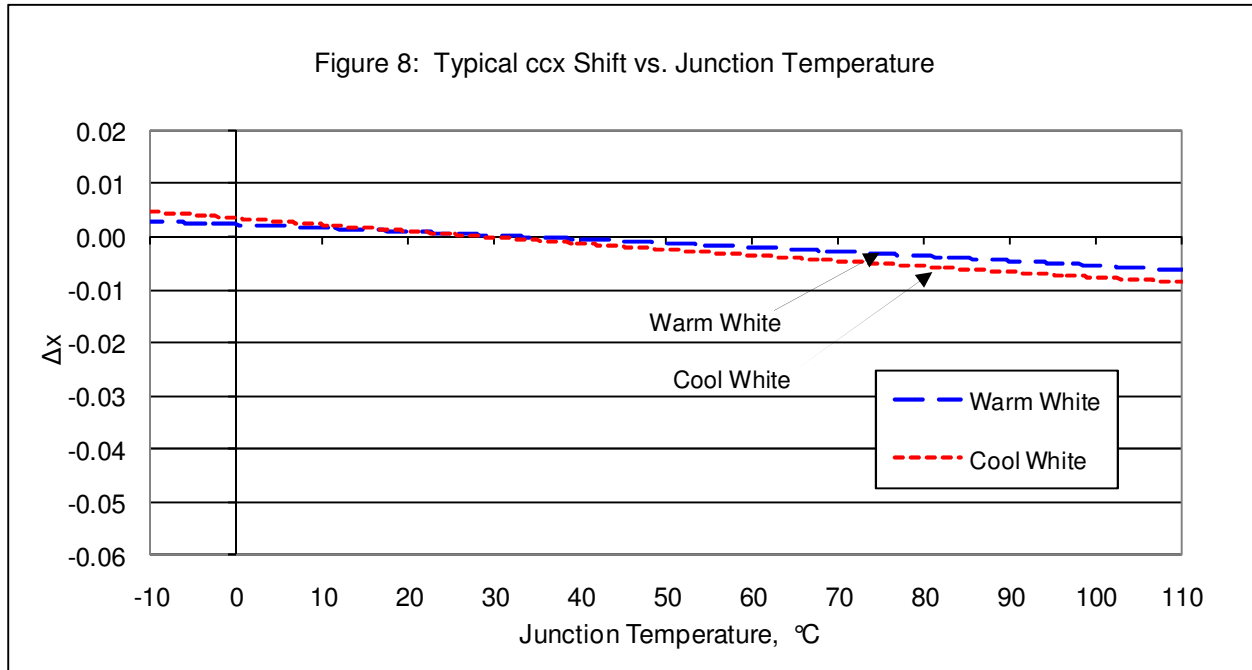

Typical Forward Current Characteristics at  $T_j = 25^\circ\text{C}$

Figure 10: Typical Current vs. Voltage, BXR-B-XXX0360-B-00, BXR-B-XXX0470-B-00

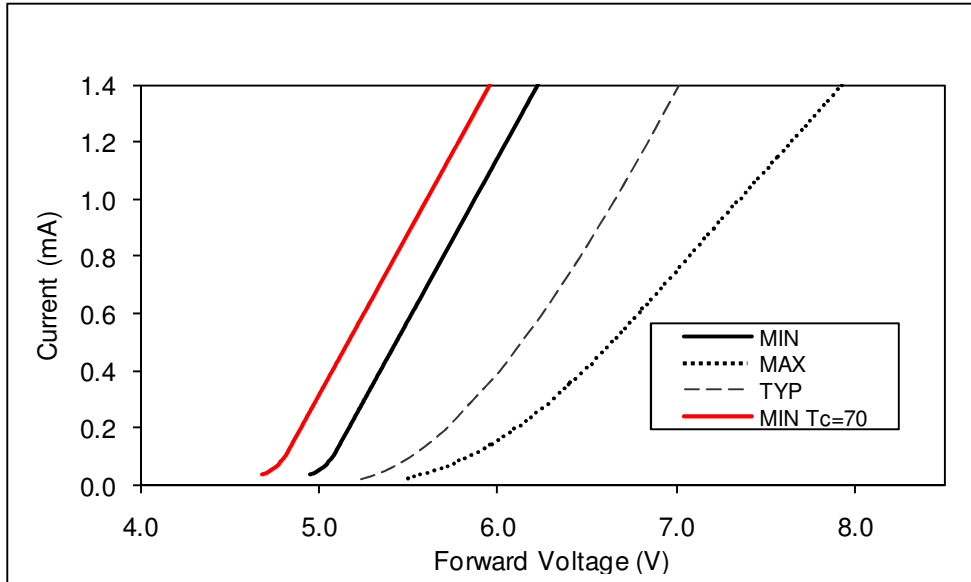
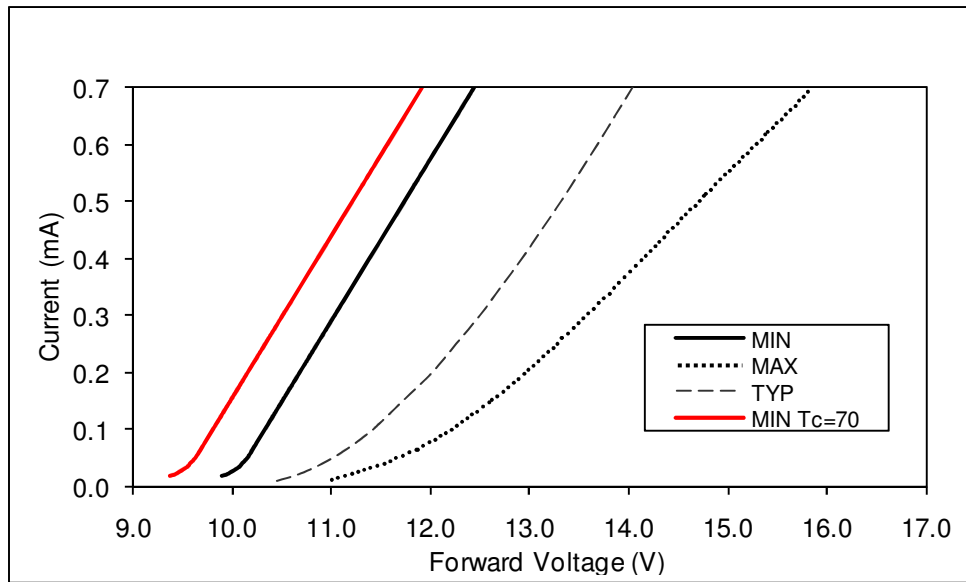

Figure 11: Typical Current vs. Voltage, BXR-B-XXX0360-A-00, BXR-B-XXX0470-A-00



---

## Product Binning

Typical manufacturing processes of semiconductor products result in a variation in performance surrounding the typical data sheet values. In order to minimize variation in the end product or application, Bridgelux bins its LED Arrays for color.

Bridgelux LED Arrays are labeled using a 2-digit alphanumeric bin code. This bin code is printed on the back of each LED Array in the following format:

A B

Where:

A B – designates color bin (P3, P4, Q3, etc.)

All product packaged within a single tube are of the same color bin (or bin code). Using these codes it is possible to determine the best product utilization to deliver the consistency required in a given application.

## Color Binning Information

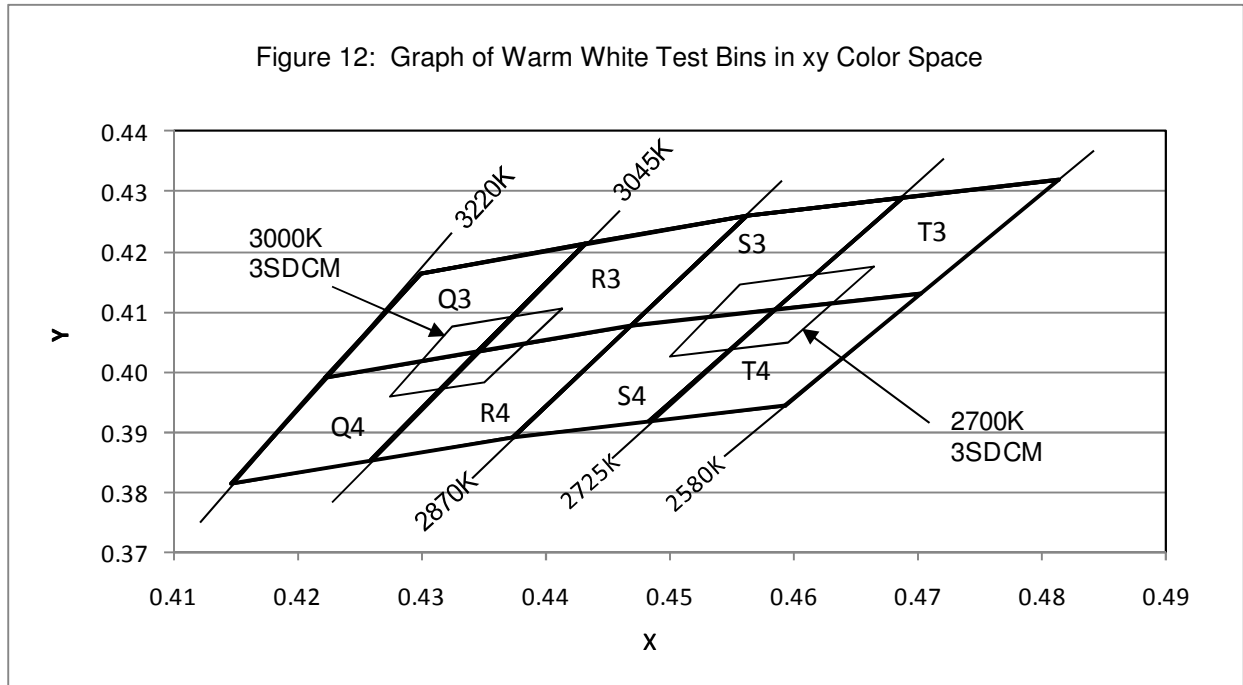

Table 9: Warm White xy Bin Coordinates and Associated Typical CCT

Bin Code	X	Y	ANSI CCT (K)
Q3	0.4223	0.3990	3000
	0.4299	0.4165	
	0.4431	0.4213	
	0.4345	0.4033	
Q4	0.4147	0.3814	3000
	0.4223	0.3990	
	0.4345	0.4033	
	0.4260	0.3854	
R3	0.4345	0.4033	3000
	0.4431	0.4213	
	0.4562	0.4260	
	0.4468	0.4077	
R4	0.4260	0.3854	3000
	0.4345	0.4033	
	0.4468	0.4077	
	0.4373	0.3893	
3SDCM	0.4413	0.4107	3000
	0.4325	0.4075	
	0.4274	0.3958	
	0.4350	0.3984	
S3	0.4468	0.4077	2700
	0.4562	0.4260	
	0.4688	0.4290	
	0.4585	0.4104	
S4	0.4373	0.3893	2700
	0.4468	0.4077	
	0.4585	0.4104	
	0.4483	0.3919	
T4	0.4585	0.4104	2700
	0.4688	0.4290	
	0.4813	0.4319	
	0.4703	0.4132	
T3	0.4483	0.3919	2700
	0.4585	0.4104	
	0.4703	0.4132	
	0.4593	0.3944	
3SDCM	0.4665	0.4175	2700
	0.4557	0.4145	
	0.4500	0.4026	
	0.4595	0.4050	

Color Binning Information (continued)

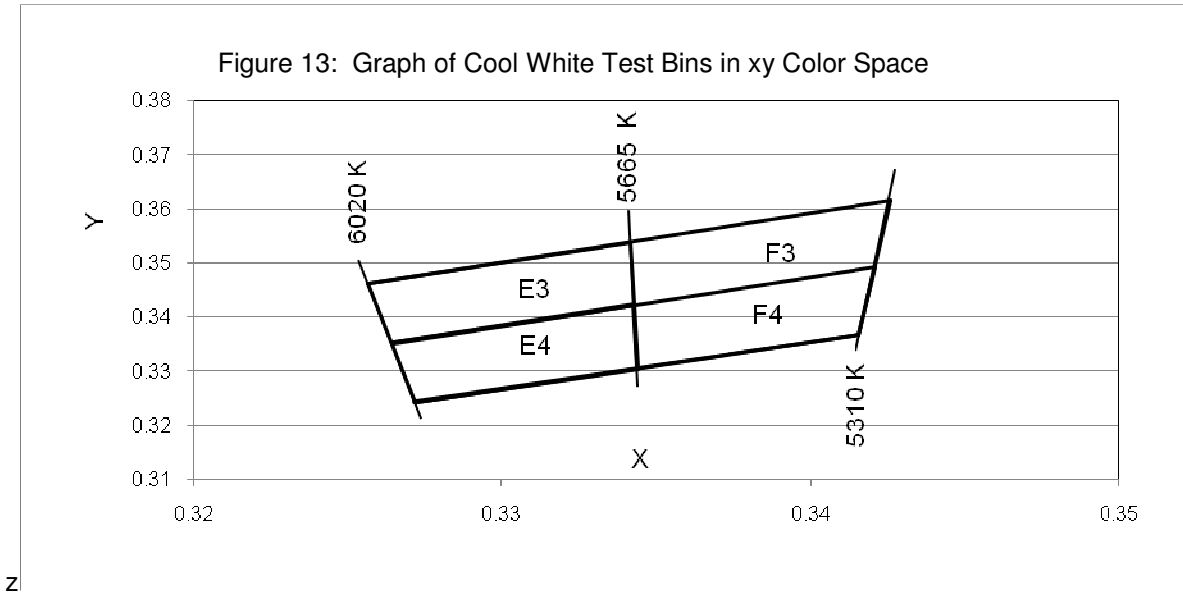

Table 10: Cool White xy Bin Coordinates and Associated Typical CCT

Bin Code	X	Y	ANSI CCT (K)
E4	0.3222	0.3243	5600
	0.3294	0.3306	
	0.3293	0.3423	
	0.3215	0.3353	
E3	0.3215	0.3353	5600
	0.3293	0.3423	
	0.3292	0.3539	
	0.3207	0.3462	
F3	0.3292	0.3539	5600
	0.3293	0.3423	
	0.3371	0.3493	
	0.3376	0.3616	
F4	0.3294	0.3306	5600
	0.3366	0.3369	
	0.3371	0.3493	
	0.3293	0.3423	

---

## Design Resources

Bridgelux has developed a comprehensive set of application notes and design resources to assist customers in successfully designing with Bridgelux LED Array products. Included below is a list of available resources which can be downloaded from the Bridgelux web site under the Design Resources section. These documents are updated regularly as new information becomes available, including complimentary infrastructure products such as commercially available secondary optics and electronic driver solutions.

### Application Notes

- AN10: Effective Thermal Management of Bridgelux LED Arrays
- AN11: Assembly Considerations for Bridgelux LED Arrays
- AN12: Electrical Drive Considerations for Bridgelux LED Arrays
- AN14: Reliability Data Sheet for Bridgelux LED Arrays
- AN15: Reflow Soldering of Bridgelux LED Arrays
- AN16: Optical Considerations for Bridgelux LED Arrays
- DS19: Bridgelux LED Array Data Sheet for Packing and Labeling

### Optical Source Models

Optical source models and ray set files are available for all Bridgelux LED Array products, and can be downloaded directly from the Bridgelux web site. The list below contains the formats currently available. If you require a specific format not included in this list, please contact your Bridgelux sales representative for assistance.

- Zemax
- ASAP
- IESNA
- LightTools
- LucidShape
- OPTIS SPEOS
- PHOTOPIA
- TracePro
- Radiant Imaging Source Model

### 3D CAD Models

Three dimensional CAD models depicting the product outline of all Bridgelux LED Arrays are available in both SAT and STEP formats. These CAD files can be downloaded directly from the Bridgelux web site.

---

## About Bridgelux

### **About Bridgelux**

Bridgelux is a leading developer and manufacturer of technologies and solutions transforming the \$40 billion global lighting industry into a \$100 billion market opportunity. Based in Livermore, California, Bridgelux is a pioneer in solid-state lighting (SSL), expanding the market for light-emitting diode (LED) technologies by driving down the cost of LED lighting systems. Bridgelux's patented light source technology replaces traditional technologies (such as incandescent, halogen, fluorescent and high intensity discharge lighting) with integrated, solid-state lighting solutions that enable lamp and luminaire manufacturers to provide high performance and energy-efficient white light for the rapidly growing interior and exterior lighting markets, including street lights, commercial lighting and consumer applications. With more than 500 patent applications filed or granted worldwide, Bridgelux is the only vertically integrated LED manufacturer and developer of solid-state light sources that designs its solutions specifically for the lighting industry.

For more information about the company, please visit [www.bridgelux.com](http://www.bridgelux.com)

© 2011 Bridgelux, Inc. All rights reserved. Product specifications are subject to change without notice.